



51.2V100AH

User Manual

Content

1. Introduction.....	3
1.2 Brief Introduction.....	4
1.3 Product Properties.....	4
2. Product Specification.....	5
2.1 Size and Weight.....	5
2.2 Performance Parameter.....	5
2.3 Equipment Interface Instruction.....	5
2.4 Battery Management System(BMS).....	9
2.4.1 BMS Protection and Alarm.....	9
3. Installation and Configuration.....	10
3.1 Preparation for installation.....	10
3.1.1 Safety Requirement.....	10
3.1.2 Environmental requirements.....	11
3.1.3 Tools and data.....	11
3.1.4 Technical preparation.....	11
3.1.5 Unpacking inspection.....	12
3.2 Equipment installation.....	14
3.2.1 Installation Steps.....	14
4. Installation and Configuration.....	18
4.1 Battery system usage and operation instructions.....	18
4.2 Alarm description and processing.....	18
4.3 Analysis and treatment of common faults.....	19

1. Introduction

1.1 Important Safety Instructions



Danger!

- Please do not put the battery into water or fire, in case of explosion or any other situation that might endanger your life.
- Please connect wires properly while installation, do not reverse connect.
To avoid short circuit, please do not connect positive and negative poles with conductor on the same device.
- Please avoid any form of damage to battery, especially stab, hit, trample or strike.



Danger!

- Please shut off the power completely when removing the device or reconnecting wires during the daily use or it could cause the danger of electric shock.
- Please use dry powder extinguisher to put out the flame when encountering a fire hazard, liquid extinguisher could result in the risk of explosion.
- For your safety, please do not arbitrarily dismantle any component in any circumstances. The maintenance must be implemented by authorized technical personnel or our company's technical support. Device breakdown due to unauthorized operation will not be covered under warranty.



Caution!

- Our products have been strictly inspected before shipment. Please contact us if you find any abnormal phenomena such as device outer case bulging.
- The product shall be grounded properly before use in order to ensure your safety.
- To assure the proper use please make sure parameters among the relevant device are compatible and matched.
- Please do not mixed-use batteries from different manufacturers, different types and models, as well as old and new together.



Caution!

- Ambient and storage method could impact the product life span, please comply with the operation environment instruction to ensure device works in proper condition.
- For long-term storage, the battery should be recharged once every 6 months, and the amount of electric charge shall exceed 80% of the rated capacity.
- Please charge the battery in 18 hours after it fully discharged or over-discharging protection mode is activated.
- Formula of theoretical standby time: $T=C/I$ (T is standby time, C is battery capacity, I is total current of all loads).

1.2 Brief Introduction

lithium iron phosphate battery system is a standard battery system unit, customers can choose a certain number of lithium battery according to their needs, by connecting parallel to form a larger capacity battery pack, to meet the user's long-term power supply needs. The product is especially suitable for energy storage applications with high operating temperatures, limited installation space, long power backup time and long service life.

1.3 Product Properties

energy storage product's positive electrode materials are lithium iron phosphate, battery cells are managed effectively by BMS with better performance, the system's features as below:

- The whole module is non-toxic, non-polluting and environmentally friendly;
- Cathode material is made from LiFePO₄ with safety performance and long cycle life
- Battery management system with better performance, possesses protection function like over-discharge, over-charge, over-current, abnormal temperature.
- Self-management on charging and discharging, Single core balancing function.
- Intelligent design configures integrated inspection module.
- Flexible configuration, multiple battery modules can be in parallel for expanding capacity and power.
- Flexible configurations allow parallel of multi battery for longer standby time.
- Self-ventilation with lower system noise.
- Less battery self-discharge, then recharging period can be up to 10 months during the storage.
- No memory effect so that battery can be charged and discharged shallowly.
- With wide range of temperature for working environment, -20°C ~ +55°C, circulation span and discharging performance are well under high temperature.
- Small size and light weight, standard of 19-inch embedded designed module is comfortable for installation and maintenance;

2. Product Specification

2.1 Size and Weight

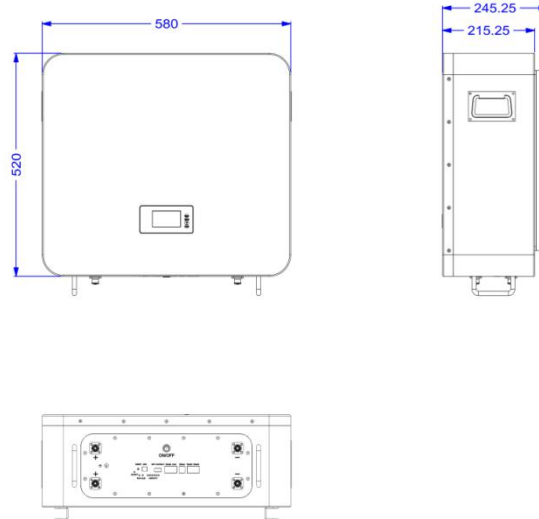

Table 2-1 Device size

Product	Nominal Voltage	Nominal Capacity	Dimension	Weight
51.2V100Ah	DC 51.2V	100AH	520*580*215	60KG

2.2 Performance Parameter

Table 2-2 performance parameter

Basic Parameters	Numerical
Nominal Voltage (V)	51.2
Nominal Capacity (WH)	5120
Usable Capacity (WH)	4600
Discharge Voltage (V)	40
Charge Voltage (V)	58.4
Recommend Charge/Discharge Current (A)	50
Max. Charge/Discharge Current(A)	100
Communication	RS485/RS232/CAN
Working Temperature	0°C~50°C Charge -10°C ~50°C Discharge
Shelf Temperature	-20°C~60°C
Certification	CE/IEC/UL/UN38.3/MSDS
Design Life	10 years+
Cycle Life	>6000

2.3 Equipment Interface Instruction

This section details the front and back interface functions of the lithium battery

Product Front Interface :

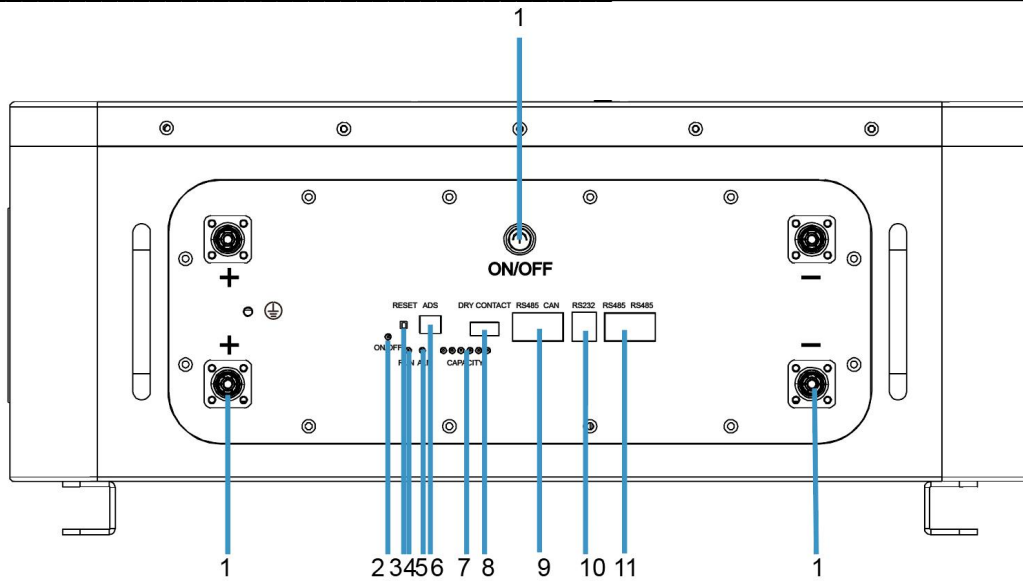

Table 2-3 Interface Definition

Item	Name	Definition
1	Power switch	ON/ OFF, must be in the "ON" state when in use
2	Status indicator	The green light will stay on when the battery the battery starts
3	RESET	Keep pressing for more than 3 seconds, the battery will be restarted
4	RUN	Green light flashing during standby and charging mode. Green light always on when discharging.
5	ALM	Red light flashing when an alarm occurs, red light always on during protection status. After the condition of trigger protection is relieved, it can be automatically closed
6	ADD	DIP switch
7	SOC	The number of green lights shows the remaining power.
8	DRY CONTACT	/
9	CAN/RS485	Communication cascade port, support CAN/ RS485
10	RS232	Communication cascade port, support RS232
11	RS485/RS485	Communication cascade port, support RS485
12	Positive socket	Battery output positive or parallel positive line
13	Negative socket	Battery output negative or parallel negative line

2.3.1 ADD switch definition and description

DIP switch description:

When packs are used in parallel, use the DIP switch on the BMS to set the address to distinguish different Packs. Do not set the address to the same.

Set the host communicates with the slaves through the RS485 interface. The host summarizes the information of the entire battery system and communicates with the inverter through CAN or 485. See the following table for the definition of the dip switch.

1. When using packs in parallel, put the Pack DIP switch “#1” to the “ON” position (to the top), this pack is the Master. This pack in charge of communicate with inverter.



2. After set the Master, other packs should set to slaver. From slaver 1 to slaver 42, set follow table



	#1	#2	#3	#4
Pack 1	ON	OFF	OFF	OFF
Pack 2	OFF	ON	OFF	OFF
Pack 3	ON	ON	OFF	OFF
Pack 4	OFF	OFF	ON	OFF
Pack 5	ON	OFF	ON	OFF
Pack 6	OFF	ON	ON	OFF
Pack 7	ON	ON	ON	OFF
Pack 8	OFF	OFF	OFF	ON
Pack 9	ON	OFF	OFF	ON
Pack 10	OFF	ON	OFF	ON
Pack 11	ON	ON	OFF	ON
Pack 12	OFF	OFF	ON	ON
Pack 13	ON	OFF	ON	ON
Pack 14	OFF	ON	ON	ON
Pack 15	ON	ON	ON	ON



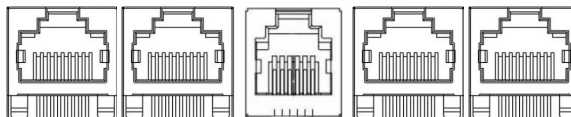
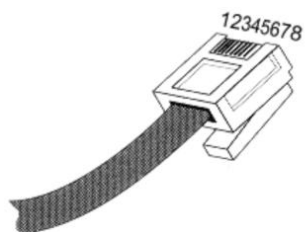





2.3.2 CAN/485/RS232 interface definition



RS485	CAN	RS232	RS485	RS485
For Inverter		Software	For pack parallel	

	PIN position	Color	Definition
RS485	PIN1	Orange/White	485B1
	PIN2	Orange	485A1
	PIN3	Green/White	GND
	PIN4	Blue	NC
	PIN5	Blue/White	NC
	PIN6	Green	GND
	PIN7	Brown/White	485A2
	PIN8	Brown	485B2
CAN	PIN1	Orange/White	NC
	PIN2	Orange	NC
	PIN3	Green/White	NC
	PIN4	Blue	CANH
	PIN5	Blue/White	CANL
	PIN6	Green	NC
	PIN7	Brown/White	GND
	PIN8	Brown	NC
RS232	PIN1		Reserve
	PIN2		GND
	PIN3		TXD
	PIN4		RXD
	PIN5		GND
	PIN6		Reserve

2.3.4 LED status indicator

Battery Status	Normal/ ALM/ Protection	ON/ OFF	RUN	ALM	SOC						Remark
											
Shutdown	Sleep	OFF	OFF	OFF	OFF	OFF	OFF	OFF	OFF	OFF	
Standby	Normal	ON	FLASH	OFF	According to the remaining battery indicator						
	ALM	ON	FLASH	FLASH							
Charge	Normal	ON	ON	OFF	According to the remaining battery indicator						
	ALM	ON	ON	FLASH							
	Protection	ON	ON	OFF							
	Protection	ON	OFF	ON							
Discharge	Normal	ON	FLASH	OFF	According to the remaining battery indicator						
	ALM	ON	FLASH	FLASH							
	Protection	ON	OFF	OFF							
	Protection	ON	OFF	ON							
Invalid		OFF	OFF	ON							

2.4 Battery Management System(BMS)

2.4.1 BMS Protection and Alarm

Over Voltage Alarm/Protection in Charging:

When total voltage or any battery cell voltage reaches the rated alarm value during charging stage, the alarm light will flash. When reaches the rated protection value, the alarm light will on, battery will stop charge. After total voltage or all cell voltage back to rated range, the protection is over

Low Voltage Protection in Discharging:

Battery system will stop supply power to the outside, when any battery cell voltage or total voltage is lower than the rated protection value during discharging, the over-discharging protection is activated. When the voltage of each cell back to rated return range, the protection is over.

Over Current Protection in Charging:

When the charge current $> 100A$, current limit protection mode is activated, current will be limited to 10A, protection is removed after rated time delaying 10S. Circulate like this until the current is lower than 100A.

Over Current Protection in Discharging:

When the discharge current is higher than 100A, the battery buzzer alarms and the system stops discharging after 15s. After protection, the discharging will restore in 60s delay or immediately when there is charging current.

Low/Over temperature protection in charging:

When battery's temperature is beyond range of $-5\text{ }^{\circ}\text{C} \sim +55\text{ }^{\circ}\text{C}$ during charging, temperature protection is activated, device stops charging.

The protection is over when temperature back to rated working range.

Low/Over temperature protection in discharging:

When battery's temperature is beyond range of $-20\text{ }^{\circ}\text{C} \sim +55\text{ }^{\circ}\text{C}$ during discharging, temperature protection is activated, device stops supplying power to the outside.

The protection is over when temperature back to rated working range.

Short Circuit Protection:

When the battery is activated from the shutdown state, if a short circuit occurs, the system starts short-circuit protection for 60 seconds.

Self-Shutdown:

When device connects no external loads and power supply and no external communication for over 72 hours, device will dormant standby automatically.

3. Installation and Configuration

3.1 Preparation for installation

3.1.1 Safety Requirement

This system can only be installed by personnel who have been trained in the power supply system and have sufficient knowledge of the power system.

The safety regulations and local safety regulations listed below should always be followed during the installation.

- All circuits connected to this power system with an external voltage of less than 51.2V must meet the SELV requirements defined in the IEC60950 standard.
- If operating within the power system cabinet, make sure the power system is not charged. Battery devices should also be switched off.
- Distribution cable wiring should be reasonable and has the protective measures to avoid touching these cables while operating power equipment.
- when installing the battery system, must wear the protective items below:

		
<p>he isolation gloves</p>	<p>Safety goggles</p>	<p>Safety shoes</p>

3.1.2 Environmental requirements

Working temperature: -20°C ~ +55°C

Charging temperature range is 0°C~+55°C,

Discharging temperature range is -20°C ~+55°C

Storage temperature: -10°C~ +35°C

Relative humidity: 5% ~ 85%RH

Elevation: no more than 4000m

Operating environment: Indoor installation, sites avoid the sun and no wind, no conductive dust and corrosive gas.

And the following conditions are met:

- Installation location should be away from the sea to avoid brine and high humidity environment.
- The ground for product arrangement shall be flat and level.
- No flammable explosive materials near the installation site.
- The optimal ambient temperature is 15°C~ 30°C
- Keep away from dust and messy zones

3.1.3 Tools and data

Tools and meters that may be used are shown in table 3-1.

Table 3-1 Tool instrument

NAME	
Screwdriver (Slotted、Phillips)	Multimeter
Torque wrench	Clamp current meter
Diagonal pliers	Insulation tape
Pointed nose pliers	Temperature meter
Pliers to hold the wire	Anti-static bracelet
Stripping pliers	Cable tie
Electric drill	Tape measure

3.1.4 Technical preparation

Electrical interface check

Devices that can be connected directly to the battery can be user equipment, power supplies, or other power supplies.

- Confirm whether the user's PV power generation equipment, power supply or other power supply equipment has a DC output interface, and measure whether the DC power output voltage meets the voltage range requirements in Table 2-2.
- Confirm that the maximum discharge current capability of the DC power interface of the user's photovoltaic power generation equipment, power supply or other power supply equipment should be higher than the maximum charging current of the products used in Table 2-2.

If the maximum discharge capacity of the DC power interface of the user's photovoltaic power generation equipment is less than the maximum charging current of the products used in Table 2-2, the DC power interface of the user's photovoltaic power generation

equipment shall have a current limiting function to ensure the normal operation of the user's equipment.

- Verify that the maximum operating current of the battery-powered user equipment (inverter DC input) should be less than the maximum discharge current of the products used in Table 2-2.







The security check

- Firefighting equipment should be provided near the product, such as portable dry powder fire extinguisher.
- Automatic fire fighting system shall be provided for the case where necessary.
- No flammable, explosive and other dangerous materials are placed beside the battery.

3.1.5 Unpacking inspection

- When the equipment arrives at the installation site, loading and unloading should be carried out according to the rules and regulations, to prevent from being exposed to sun and rain.
- Before unpacking, the total number of packages shall be indicated according to the shipping list attached to each package, and the case shall be checked for good condition.
- In the process of unpacking, handle with care and protect the surface coating of the object.
- Open the package, the installation personnel should read the technical documents, verify the list, according to the configuration table and packing list, ensure objects are complete and intact, if the internal packing is damaged, should be examined and recorded in detail.

Packing list is as follows:

Item	Specification	Quantity	Figure
Battery	51.2V/100AH	/	
Positive Cable to inverter	Red/25mm ² /L2000mm	/	
Negative Cable to inverter	Black/25mm ² /L2000mm	/	
Positive Cable for parallel	Red/25mm ² /L1000mm	/	
Negative Cable for parallel	Black/25mm ² /L1000mm	/	
Communication Cable for parallel	L1000mm	/	
Communication Cable to inverter	L2000mm	/	
User Manual		/	

3.2 Equipment installation

3.2.1 Installation Steps

Step 1 Mechanical Installation

- (1) According to the hole position of the battery back bracket, find the corresponding hole position on the wall and install the expansion screw

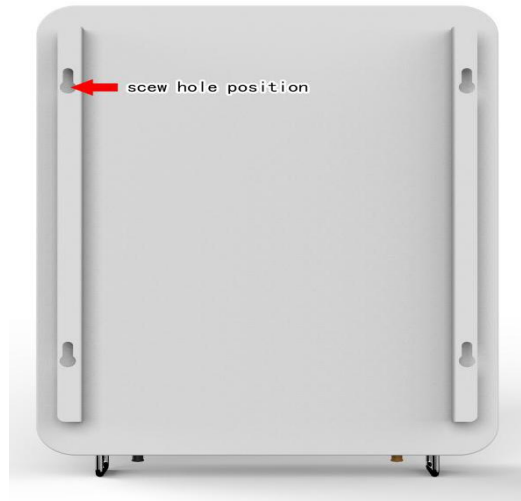

- (2) Hang the battery on the bracket to ensure stability



Step 2 Electrical installation

(1) Connect with inverter power lower than 5kw (including 5kw)

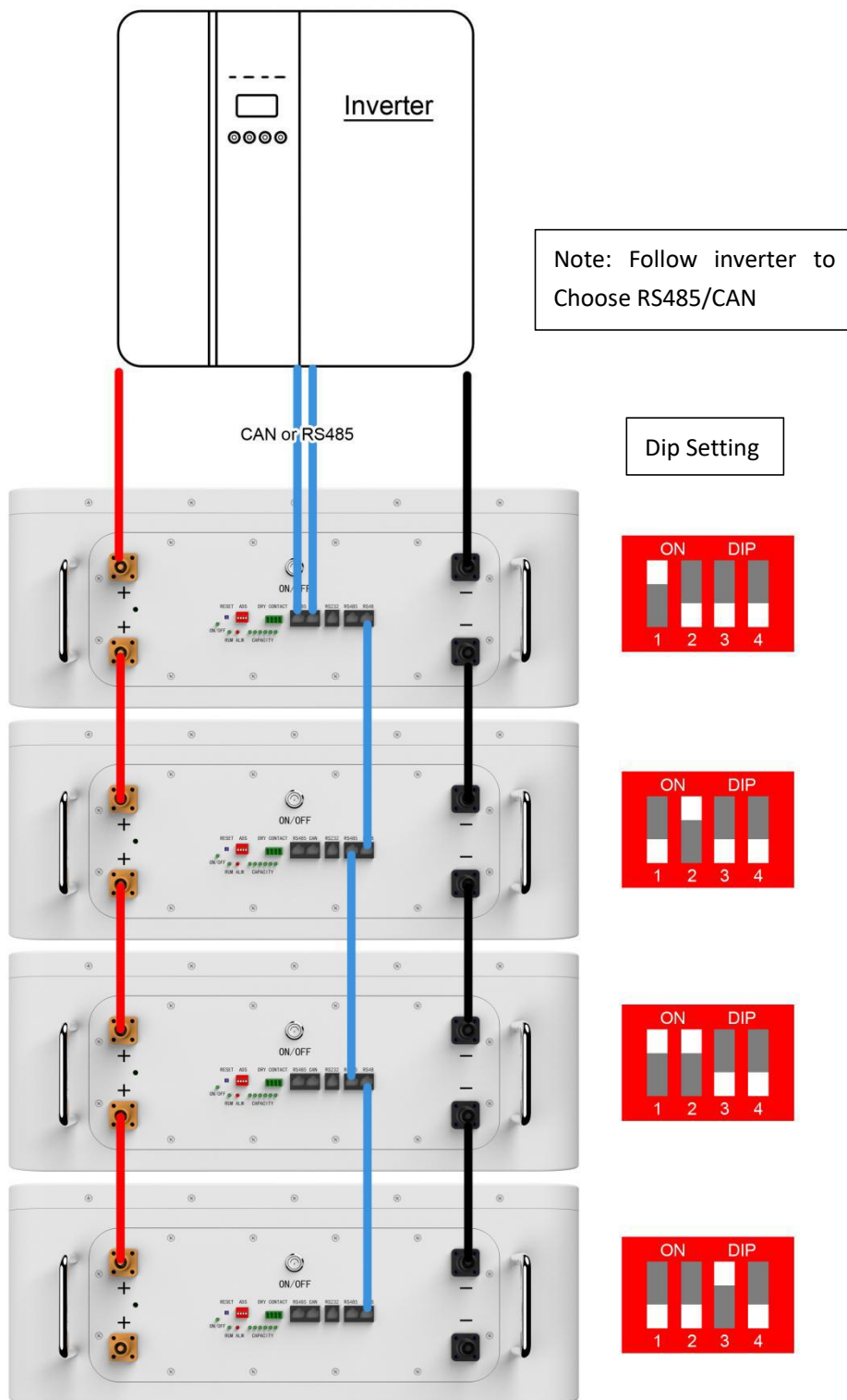

(2) Connect with inverter power higher than 5kw

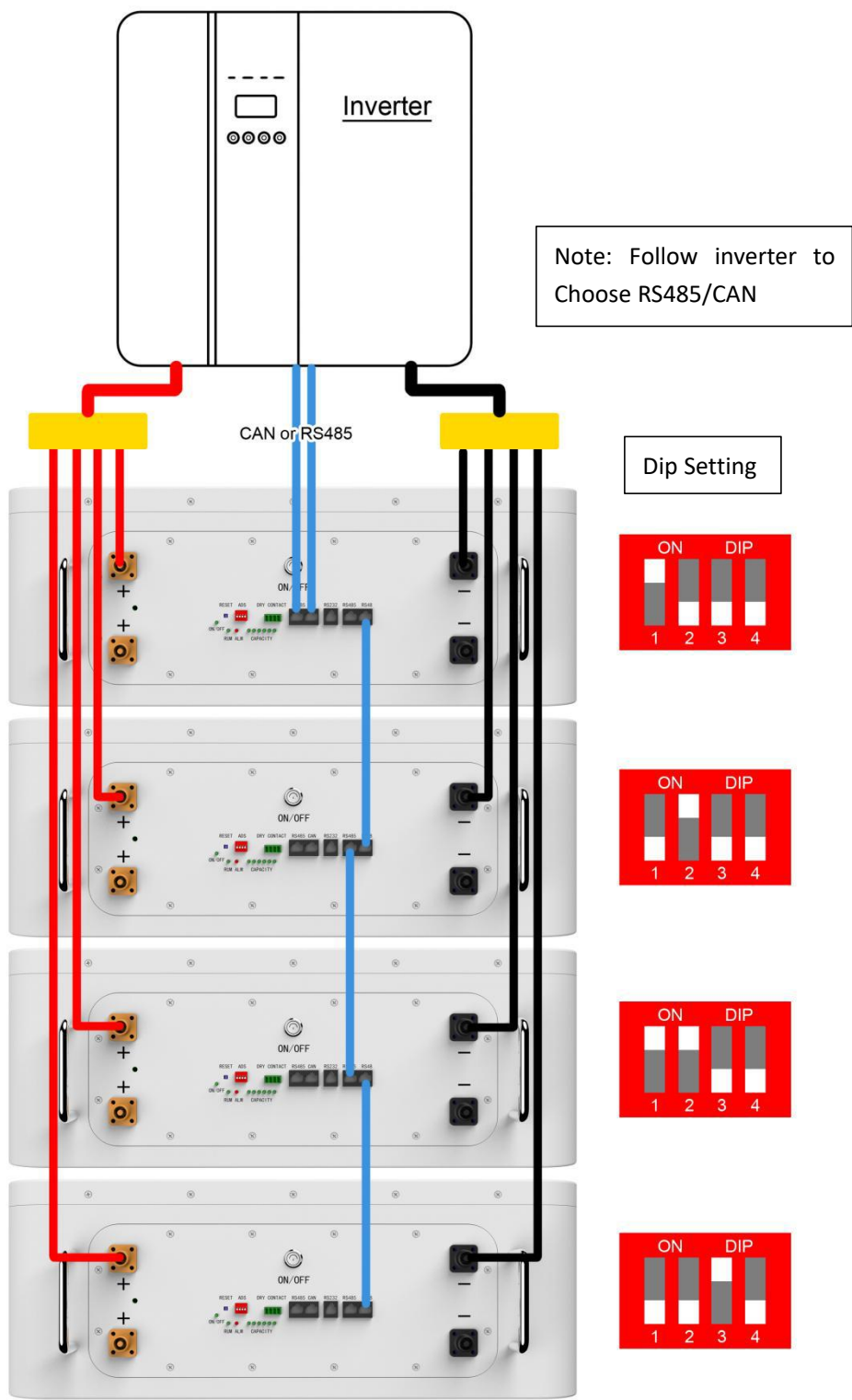

(3) Connect with Inverter connected in parallel

Note: Follow inverter to Choose RS485/CAN

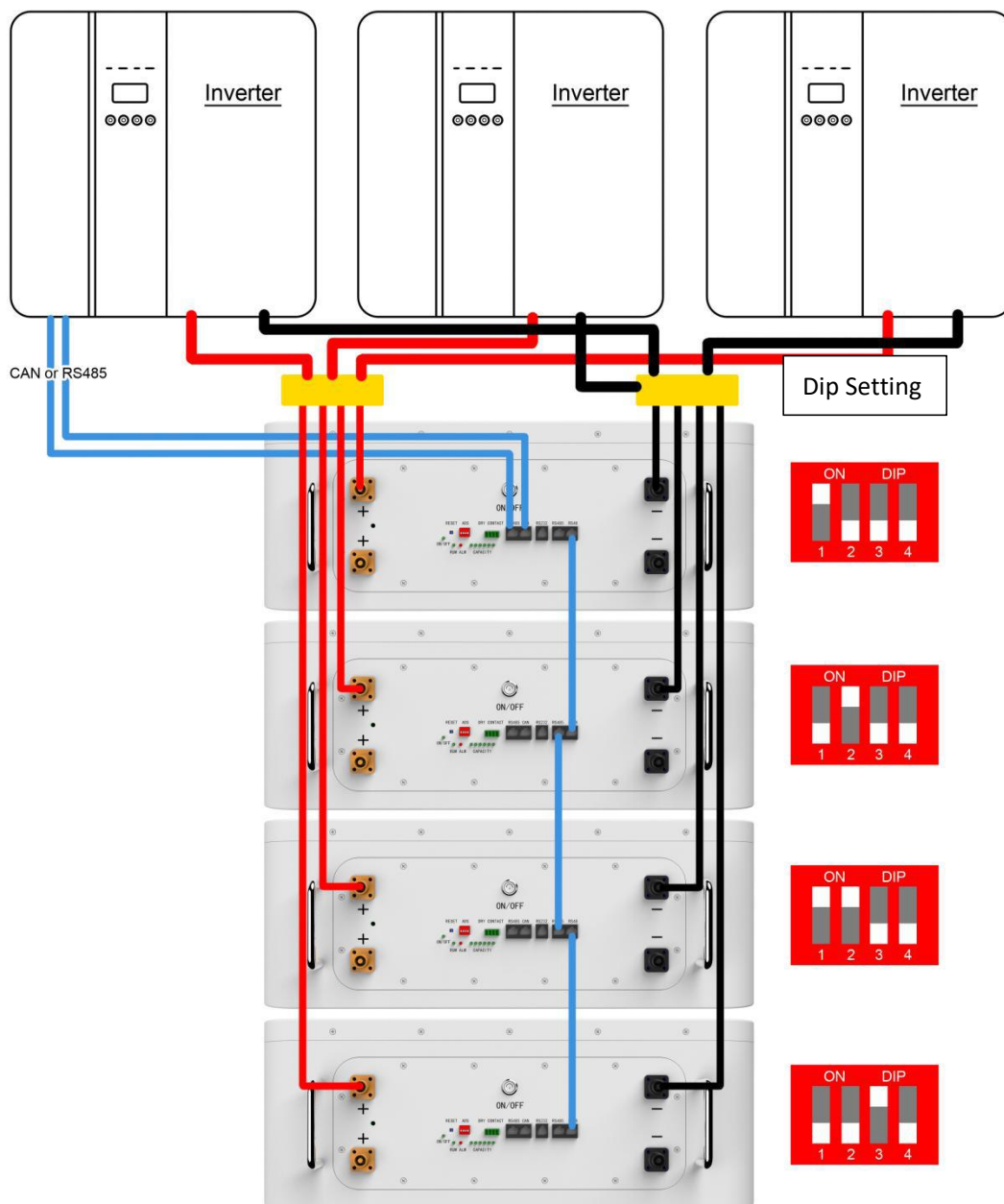

3.2.2 Battery parameter settings on the inverter

If your inverter do not have communication function with 51.2V100AH battery pack, please set inverter follow next data.

Max Charging(Bulk) Voltage: 57V

Absorption Voltage: 56.5V

Float Voltage: 56V

Shut Down(cut off) Voltage: 49V

Shut Down(cut off) SOC: 20%

Restart Voltage: 51.2V

Max Charge Current: 100A*battery QTY

Max Discharge Current: 100A*battery QTY

4. Installation and Configuration

4.1 Battery system usage and operation instructions

After completing the electrical installation, follow these steps to start the battery system.

1. Refer to the description of the DIP switch of 2.3.1 to prepare the battery module before starting up, then press the ON/OFF button to the ON position.
2. After the indicator self-test, the RUN indicator will light and the SOC indicator will be on (50% SOC status in the 2.3.4).



1. After pressing the power button, if the battery status indicator on the front panel continues to be red, please refer to the "4.2 Alarm description and processing ". If the failure cannot be eliminated, please contact the dealer timely.

2. Use a voltmeter to measure whether the voltage of the circuit breaker battery access terminal is higher than 48V, and check whether the voltage polarity is consistent with the inverter input polarity. If the circuit breaker battery input terminal has a voltage output and is greater than 48V, then the battery begun to work normally.

3. After confirming that the battery output voltage and polarity are correct, turn on the inverter, close the circuit breaker.

4. Check if the indicator of the inverter and battery connection (communication indicator and battery access status indicator) is normal. If it is normal, successfully complete the connection between the battery and the inverter. If the indicator light is abnormal, please refer to the inverter manual for the cause

4.2 Alarm description and processing

When protection mode is activated or system failure occurred, the alarm signal will be given through the working status indicator on the front panel of the battery. The network management can query the specific alarm categories.

If the fault such as single cell over voltage, charging over-current, under-voltage protection, high-temp protection and other abnormalities which affects the output, please deal with it according to Table 4-1.

Table 4-1 Main alarm and Protection

Statue	Alarm category	Alarm indication	Processing
Charge state	Over-current	RED	Stop charging and find out the cause of the trouble
	High temp	Red	Stop charging
Discharge state	Over-current	Red	Stop discharging and find out the cause of the trouble
	High temp	Red	Stop discharging and find out the cause of the trouble
	Total voltage undervoltage	Red	Start charging
	Cell voltage undervoltage	Red	Start charging

4.3 Analysis and treatment of common faults

Analysis and treatment of common faults in the Table 4-2:

Table 4-2 Analysis and treatment of common faults

No.	Fault phenomenon	Reason analysis	Solution
1	The indicator does not respond after the power on Total voltage lower than 37.5V Check the total voltage	Total voltage lower than 37.5V	Check the total voltage
2	No DC output	Battery data status is abnormal. Battery gets into over-discharged protection	Read the battery information on the monitor.
3	The DC power supply time is too short	Battery capacity become smaller	Storage battery replacement or add more modules
4	The battery can't be fully charged to 100%	Charging voltage is too low	Adjust charging voltage at 57V
5	The power cable sparks once power on and ALM light RED	Power connection short-circuit	Turn off the battery, check the cause of the short circuit

6	Communication fault	<p>The DIP setting of the host is wrong/ the battery type of the inverter is wrong/ Communication cable used incorrectly/The communication cable is incorrectly connected at the battery communication port or the inverter communication port/The battery firmware version is too low to support the inverter</p>	Check these possible causes one by one
---	---------------------	---	--

If you need any technical help or have any question, please contact the dealer in time.